



**PART NO. : EOS-9VxWCD0-EG**



**SMD 3020**

**PLCC-2 Series- White / Warm White Color (CRI>80)**

**Data Sheet**

## **Features**

- InGaN chip technology
- High efficiency / high light output
- Wide viewing angle
- Pb free and RoHS compliant product
- SMT compatible package

## **Applications**

- Automotive lighting
- LED display
- Backlighting  
(LCD, display, switch, office equipment)
- Indicator
- Channel letter

## Outline Drawing

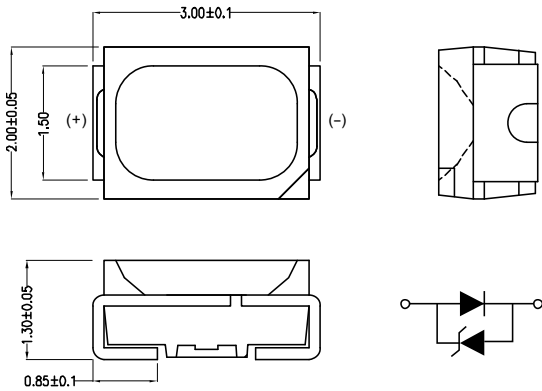

## Beam Pattern

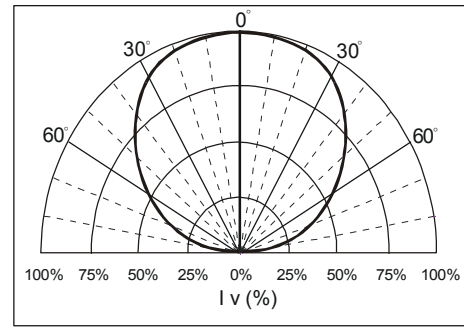

## Recommended Soldering Pad

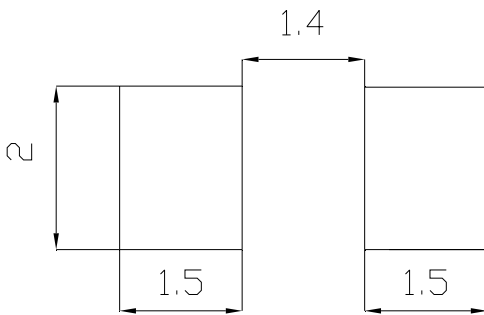

Note:

1. All dimensions are in millimeter.
2. Tolerance is  $\pm 0.20\text{mm}$  unless otherwise noted.
3. Specifications are subject to change without notice.

## Absolute Maximum Ratings at $T_A=25^\circ\text{C}$

| Parameter  | Symbol            | Max.  | Unit             |
|--|-------------------|---|------------------|
| Average Forward Current <sup>[1]</sup>                         | $I_F$             | 30  | mA               |
| Peak Forward Current <sup>[2]</sup>                            | $I_{\text{peak}}$ | 60  | mA               |
| Power Dissipation  | $P_D$             | 108   | mW               |
| LED Junction Temperature                                       | $T_J$             | 125   | $^\circ\text{C}$ |
| Operating Temperature Range <sup>[1]</sup>                     | $T_{\text{OPR}}$  | -40 ~ 100                                   | $^\circ\text{C}$ |
| Storage Temperature Range                                      | $T_{\text{STO}}$  | -40 ~ 100                                   | $^\circ\text{C}$ |
| Thermal Resistance (Junction / Soldering Point) <sup>[3]</sup> | $R_{\theta JS}$   | 180 (Typ.)                                  | K/W              |
| Lead Soldering Condition (Reflow)                              | $T_{\text{SOL}}$  | Below $260^\circ\text{C}$ , Max. 10 seconds |                  |

- Note: 1. Design of heat dissipation should be considered. For the allowable operating current at different operating temperature, please refer to fig 4. page 9.  
 2. Duty ratio=1/10, pulse width=0.1ms.  
 3. This value is taken from a statistical sampling, and is provided for reference only. It's recommended to build in a safety margin for the design of heat dissipation, to ensure LEDs perform normally and optimally.

**Device Selection Guide (Electrical and Optical Characteristics at  $T_A=25^\circ\text{C}$ )**

| Part Number<br>EOS- | Emitting<br>Color | Driving<br>Current<br>$I_F(\text{mA})$ | Chromaticity | Luminous<br>Intensity<br>$I_V(\text{mcd})$ |      | Total Flux<br>$\Phi_V(\text{mlm})/$<br>$I_V(\text{mcd})$ <sup>[1]</sup> | CCT(K) <sup>[2]</sup> |       |
|---------------------|-------------------|--|--------------|--|------|---|-----------------------|-------|
|                     |                   |  | Typ.         | Min.                                       | Typ. | Typ.  | Min.                  | Max.  |
| 9VWWCD0-EG          | Cool White        | 20                                     | (0.30,0.31)  | 2180                                       | 2500 | 2.6   | 6000                  | 10000 |
|                     | Pure White        | 20                                     | (0.34,0.35)  | 2290                                       | 2600 | 2.6   | 4250                  | 6000  |
|                     | Neutral White     | 20                                     | (0.40,0.38)  | 2180                                       | 2500 | 2.6   | 3250                  | 4250  |
| 9VMWCD0-EG          | Warm White        | 20                                     | (0.44,0.40)  | 2070                                       | 2300 | 2.6   | 2550                  | 3250  |

| Part Number<br>EOS- | Driving<br>Current<br>$I_F(\text{mA})$ | Forward Voltage<br>$V_F(\text{V})$ |      |      | Viewing Angle<br>$2\theta_{1/2}$ |
|---------------------|--|------------------------------------|------|------|----------------------------------|
|                     |  | Min.                               | Typ. | Max. | Typ.                             |
| 9VWWCD0-EG          | 20                                     | 2.8                                | 3.2  | 3.6  | 120°                             |
| 9VMWCD0-EG          | 20                                     | 2.8                                | 3.2  | 3.6  | 120°                             |

Note: 1. Total flux value is a typical value for reference only.

2. LEDs are binned by chromaticity, and CCT is a reference value.

**Luminous Intensity Distribution Table**

| Part Number<br>EOS- | Emitting<br>Color | Luminous Intensity Bin Rank<br>$I_V(\text{mcd})@I_F=20\text{mA}$ |           |           |           |           |           |           |
|---------------------|-------------------|--|-----------|-----------|-----------|-----------|-----------|-----------|
|                     |                   | 4P   | 4Q        | 4R        | 4S        | 4T        | 4U        | 4V        |
|                     |                   | 2070-2180  | 2180-2290 | 2290-2400 | 2400-2550 | 2550-2700 | 2700-2850 | 2850-3000 |
| 9VWWCD0-EG          | Cool White        |  | ○         | ●         | ●         | ●         | ○         |           |
|                     | Pure White        |  |           | ○         | ●         | ●         | ●         | ○         |
|                     | Neutral White     |  | ○         | ●         | ●         | ●         | ○         |           |
| 9VMWCD0-EG          | Warm White        | ○  | ●         | ●         | ●         | ○         |           |           |

Note: 1. [O] Bin with less distribution.

2. Measurement uncertainty of luminous intensity:  $\pm 10\%$ .

### Forward Voltage Bin Rank

| Color                 | Forward Voltage<br>$V_F(V)@I_F=20mA$ |      |          |
|-----------------------|--------------------------------------|------|----------|
|                       | Min.                                 | Max. | Bin Rank |
| White /<br>Warm White | 2.8                                  | 2.9  | 1        |
|                       | 2.9                                  | 3.0  | 2        |
|                       | 3.0                                  | 3.1  | 3        |
|                       | 3.1                                  | 3.2  | 4        |
|                       | 3.2                                  | 3.3  | 5        |
|                       | 3.3                                  | 3.4  | 6        |
|                       | 3.4                                  | 3.5  | 7        |
|                       | 3.5                                  | 3.6  | 8        |

Note: 1. Measurement uncertainty of forward voltage:  $\pm 0.1V$

### CIE Bin Rank

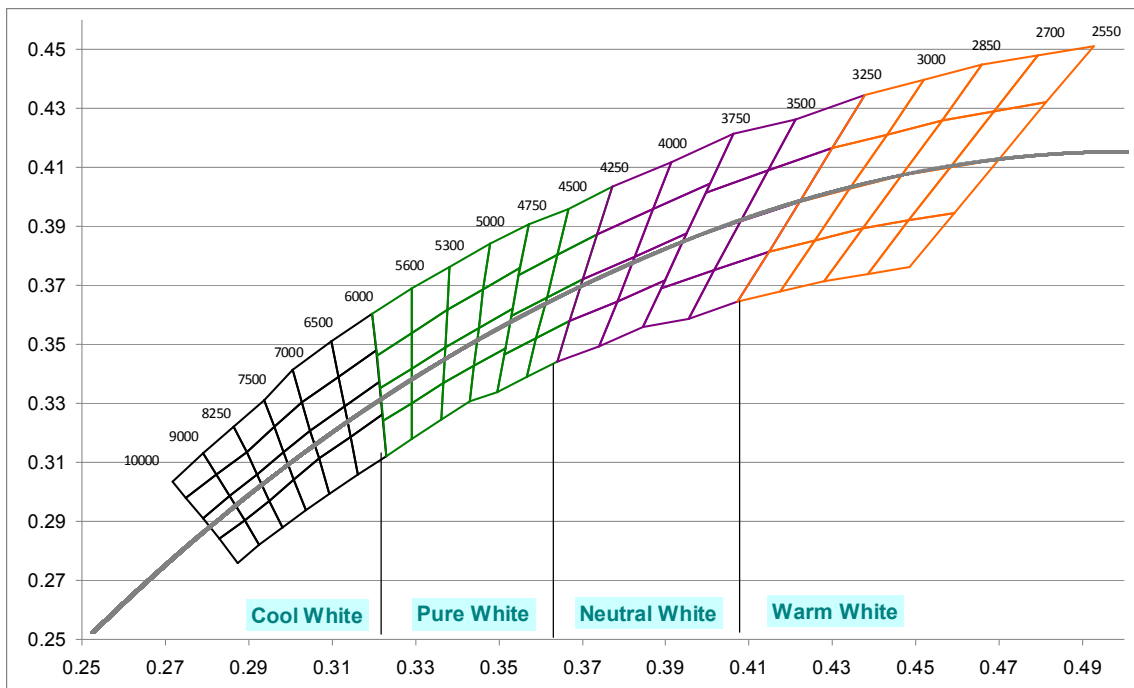

## Chromaticity Coordinate Specifications for Cool White

|                 |        |        |        |
|-----------------|--------|--------|--------|
| AA(9000-10000K) |        |        |        |
| 0.2830          | 0.2790 | 0.2855 | 0.2890 |
| 0.2840          | 0.2910 | 0.2985 | 0.2905 |
| AB(8250-9000K)  |        |        |        |
| 0.2890          | 0.2855 | 0.2920 | 0.2950 |
| 0.2905          | 0.2985 | 0.3060 | 0.2970 |
| AC(9000-10000K) |        |        |        |
| 0.2790          | 0.2750 | 0.2823 | 0.2855 |
| 0.2910          | 0.2980 | 0.3058 | 0.2985 |
| AD(8250-9000K)  |        |        |        |
| 0.2855          | 0.2823 | 0.2895 | 0.2920 |
| 0.2985          | 0.3058 | 0.3135 | 0.3060 |
| AR(9000-10000K) |        |        |        |
| 0.2874          | 0.2830 | 0.2890 | 0.2925 |
| 0.2760          | 0.2840 | 0.2905 | 0.2820 |
| AU(8250-9000K)  |        |        |        |
| 0.2925          | 0.2890 | 0.2950 | 0.2980 |
| 0.2820          | 0.2905 | 0.2970 | 0.2880 |
| AS(9000-10000K) |        |        |        |
| 0.2750          | 0.2718 | 0.2790 | 0.2823 |
| 0.2980          | 0.3036 | 0.3130 | 0.3058 |
| AT(8250-9000K)  |        |        |        |
| 0.2823          | 0.2790 | 0.2864 | 0.2895 |
| 0.3058          | 0.3130 | 0.3221 | 0.3135 |
| BA(7500-8250K)  |        |        |        |
| 0.2950          | 0.2920 | 0.2984 | 0.3009 |
| 0.2970          | 0.3060 | 0.3133 | 0.3042 |
| BB(7000-7500K)  |        |        |        |
| 0.3009          | 0.2984 | 0.3048 | 0.3068 |
| 0.3042          | 0.3133 | 0.3207 | 0.3113 |
| BC(7500-8250K)  |        |        |        |
| 0.2920          | 0.2895 | 0.2962 | 0.2984 |
| 0.3060          | 0.3135 | 0.3220 | 0.3133 |
| BD(7000-7500K)  |        |        |        |
| 0.2984          | 0.2962 | 0.3028 | 0.3048 |
| 0.3133          | 0.3220 | 0.3304 | 0.3207 |
| BR(7500-8250K)  |        |        |        |
| 0.2980          | 0.2950 | 0.3009 | 0.3037 |
| 0.2880          | 0.2970 | 0.3042 | 0.2937 |
| BU(7000-7500K)  |        |        |        |
| 0.3037          | 0.3009 | 0.3068 | 0.3093 |
| 0.2937          | 0.3042 | 0.3113 | 0.2993 |
| BS(7500-8250K)  |        |        |        |
| 0.2895          | 0.2864 | 0.2937 | 0.2962 |
| 0.3135          | 0.3221 | 0.3312 | 0.3220 |
| BT(7000-7500K)  |        |        |        |
| 0.2962          | 0.2937 | 0.3005 | 0.3028 |
| 0.3220          | 0.3312 | 0.3415 | 0.3304 |
| CA(6500-7000K)  |        |        |        |
| 0.3068          | 0.3048 | 0.3130 | 0.3144 |
| 0.3113          | 0.3207 | 0.3290 | 0.3186 |
| CB(6000-6500K)  |        |        |        |
| 0.3144          | 0.3130 | 0.3213 | 0.3221 |
| 0.3186          | 0.3290 | 0.3373 | 0.3261 |
| CC(6500-7000K)  |        |        |        |
| 0.3048          | 0.3028 | 0.3115 | 0.3130 |
| 0.3207          | 0.3304 | 0.3391 | 0.3290 |
| CD(6000-6500K)  |        |        |        |
| 0.3130          | 0.3115 | 0.3205 | 0.3213 |
| 0.3290          | 0.3391 | 0.3481 | 0.3373 |
| CR(6500-7000K)  |        |        |        |
| 0.3093          | 0.3068 | 0.3144 | 0.3161 |
| 0.2993          | 0.3113 | 0.3186 | 0.3059 |
| CU(6000-6500K)  |        |        |        |
| 0.3161          | 0.3144 | 0.3221 | 0.3231 |
| 0.3059          | 0.3186 | 0.3261 | 0.3120 |
| CS(6500-7000K)  |        |        |        |
| 0.3028          | 0.3005 | 0.3099 | 0.3115 |
| 0.3304          | 0.3415 | 0.3509 | 0.3391 |
| CT(6000-6500K)  |        |        |        |
| 0.3115          | 0.3099 | 0.3196 | 0.3205 |
| 0.3391          | 0.3509 | 0.3602 | 0.3481 |

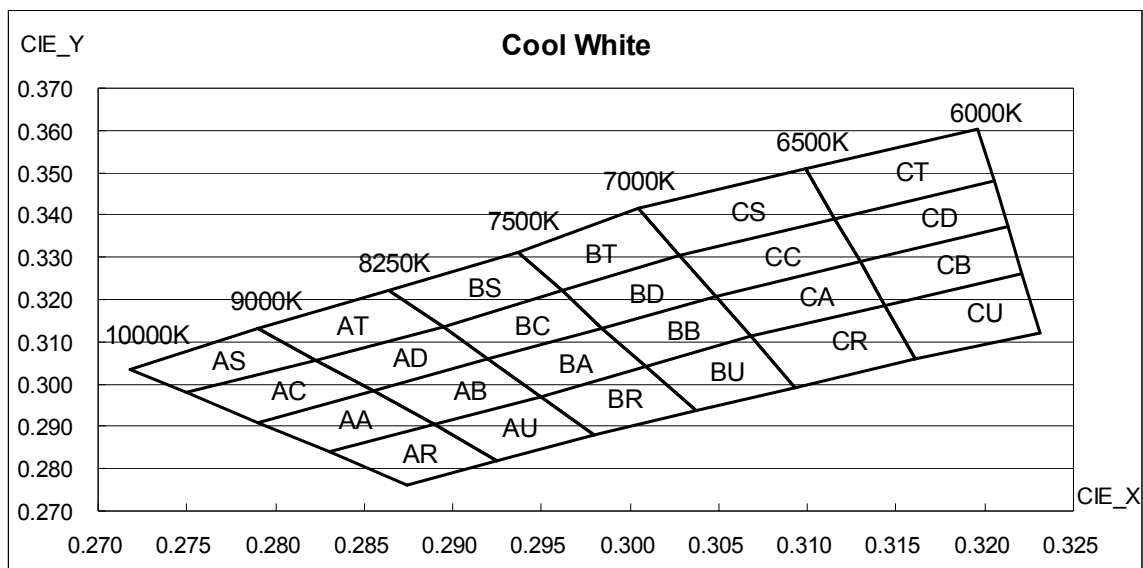

Note: Measurement uncertainty of the chromatic coordinates:  $\pm 0.01$



## Chromaticity Coordinate Specifications for Neutral White

| GA(4000-4250K) |        |        |        |
|----------------|--------|--------|--------|
| 0.3670         | 0.3702 | 0.3825 | 0.3783 |
| 0.3578         | 0.3722 | 0.3798 | 0.3646 |
| GC(4000-4250K) |        |        |        |
| 0.3702         | 0.3736 | 0.3869 | 0.3825 |
| 0.3722         | 0.3874 | 0.3958 | 0.3798 |
| GR(4000-4250K) |        |        |        |
| 0.3640         | 0.3670 | 0.3783 | 0.3741 |
| 0.3440         | 0.3578 | 0.3646 | 0.3494 |
| GS(4000-4250K) |        |        |        |
| 0.3736         | 0.3771 | 0.3913 | 0.3869 |
| 0.3874         | 0.4034 | 0.4118 | 0.3958 |
| GB(3750-4000K) |        |        |        |
| 0.3783         | 0.3825 | 0.3950 | 0.3898 |
| 0.3646         | 0.3798 | 0.3875 | 0.3716 |
| GD(3750-4000K) |        |        |        |
| 0.3825         | 0.3869 | 0.4006 | 0.3950 |
| 0.3798         | 0.3958 | 0.4044 | 0.3875 |
| GU(3750-4000K) |        |        |        |
| 0.3741         | 0.3783 | 0.3898 | 0.3846 |
| 0.3494         | 0.3646 | 0.3716 | 0.3557 |
| GT(3750-4000K) |        |        |        |
| 0.3869         | 0.3913 | 0.4062 | 0.4006 |
| 0.3958         | 0.4118 | 0.4213 | 0.4044 |
| HA(3500-3750K) |        |        |        |
| 0.3889         | 0.3941 | 0.4080 | 0.4017 |
| 0.3690         | 0.3848 | 0.3916 | 0.3751 |
| HC(3500-3750K) |        |        |        |
| 0.3941         | 0.3996 | 0.4146 | 0.4080 |
| 0.3848         | 0.4015 | 0.4089 | 0.3916 |
| HR(3500-3750K) |        |        |        |
| 0.3846         | 0.3889 | 0.4017 | 0.3954 |
| 0.3557         | 0.3690 | 0.3751 | 0.3586 |
| HS(3500-3750K) |        |        |        |
| 0.3996         | 0.4062 | 0.4212 | 0.4146 |
| 0.4015         | 0.4213 | 0.4262 | 0.4089 |
| HB(3250-3500K) |        |        |        |
| 0.4017         | 0.4080 | 0.4221 | 0.4147 |
| 0.3751         | 0.3916 | 0.3984 | 0.3814 |
| HD(3250-3500K) |        |        |        |
| 0.4080         | 0.4146 | 0.4299 | 0.4221 |
| 0.3916         | 0.4089 | 0.4165 | 0.3984 |
| HU(3250-3500K) |        |        |        |
| 0.3954         | 0.4017 | 0.4147 | 0.4073 |
| 0.3586         | 0.3751 | 0.3814 | 0.3644 |
| HT(3250-3500K) |        |        |        |
| 0.4146         | 0.4212 | 0.4377 | 0.4299 |
| 0.4089         | 0.4262 | 0.4346 | 0.4165 |

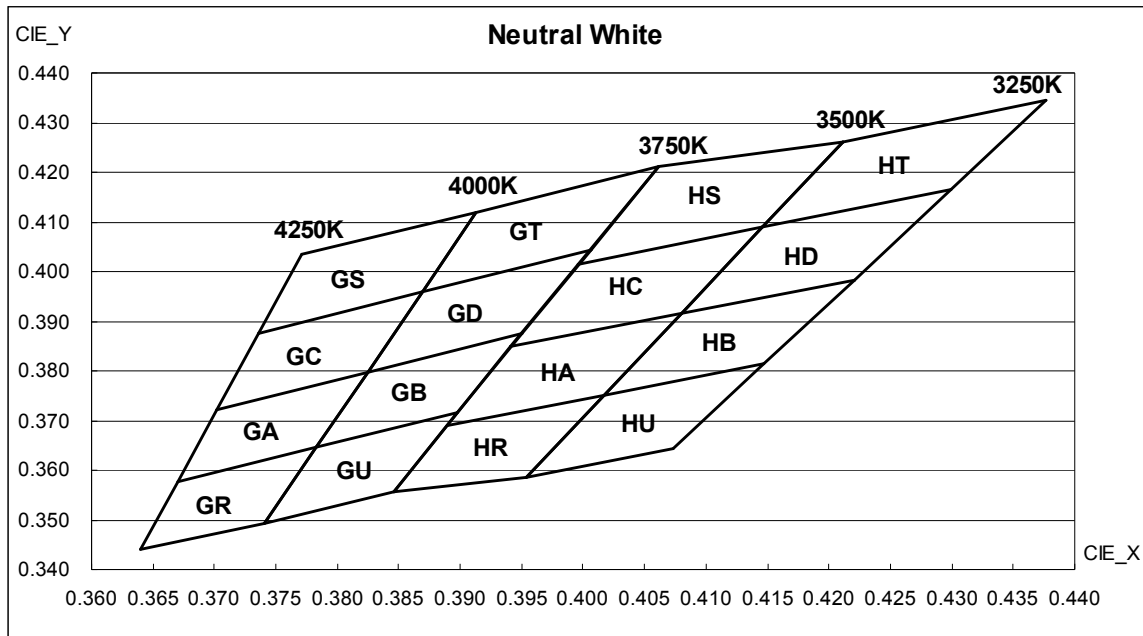

Note: Measurement uncertainty of the chromatic coordinates:  $\pm 0.01$

## Chromaticity Coordinate Specifications for Warm White

| JA(3000-3250K) |        |        |        |
|----------------|--------|--------|--------|
| 0.4147         | 0.4221 | 0.4342 | 0.4259 |
| 0.3814         | 0.3984 | 0.4028 | 0.3853 |
| JC(3000-3250K) |        |        |        |
| 0.4221         | 0.4299 | 0.4430 | 0.4342 |
| 0.3984         | 0.4165 | 0.4212 | 0.4028 |
| JR(3000-3250K) |        |        |        |
| 0.4073         | 0.4147 | 0.4259 | 0.4176 |
| 0.3644         | 0.3814 | 0.3853 | 0.3678 |
| JS(3000-3250K) |        |        |        |
| 0.4299         | 0.4377 | 0.4518 | 0.4430 |
| 0.4165         | 0.4346 | 0.4396 | 0.4212 |
| JB(2850-3000K) |        |        |        |
| 0.4259         | 0.4342 | 0.4465 | 0.4373 |
| 0.3853         | 0.4028 | 0.4071 | 0.3893 |
| JD(2850-3000K) |        |        |        |
| 0.4342         | 0.4430 | 0.4562 | 0.4465 |
| 0.4028         | 0.4212 | 0.4260 | 0.4071 |
| JU(2850-3000K) |        |        |        |
| 0.4176         | 0.4259 | 0.4373 | 0.4281 |
| 0.3678         | 0.3853 | 0.3893 | 0.3715 |
| JT(2850-3000K) |        |        |        |
| 0.4430         | 0.4518 | 0.4659 | 0.4562 |
| 0.4212         | 0.4396 | 0.4449 | 0.4260 |
| KA(2700-2850K) |        |        |        |
| 0.4373         | 0.4465 | 0.4582 | 0.4483 |
| 0.3893         | 0.4071 | 0.4099 | 0.3919 |
| KC(2700-2850K) |        |        |        |
| 0.4465         | 0.4562 | 0.4687 | 0.4582 |
| 0.4071         | 0.4260 | 0.4289 | 0.4099 |
| KR(2700-2850K) |        |        |        |
| 0.4281         | 0.4373 | 0.4483 | 0.4384 |
| 0.3715         | 0.3893 | 0.3919 | 0.3739 |
| KS(2700-2850K) |        |        |        |
| 0.4562         | 0.4659 | 0.4792 | 0.4687 |
| 0.4260         | 0.4449 | 0.4479 | 0.4289 |
| KB(2550-2700K) |        |        |        |
| 0.4483         | 0.4582 | 0.4700 | 0.4593 |
| 0.3919         | 0.4099 | 0.4126 | 0.3944 |
| KD(2550-2700K) |        |        |        |
| 0.4582         | 0.4687 | 0.4813 | 0.4700 |
| 0.4099         | 0.4289 | 0.4319 | 0.4126 |
| KU(2550-2700K) |        |        |        |
| 0.4384         | 0.4483 | 0.4593 | 0.4486 |
| 0.3739         | 0.3919 | 0.3944 | 0.3762 |
| KT(2550-2700K) |        |        |        |
| 0.4687         | 0.4792 | 0.4926 | 0.4813 |
| 0.4289         | 0.4479 | 0.4512 | 0.4319 |

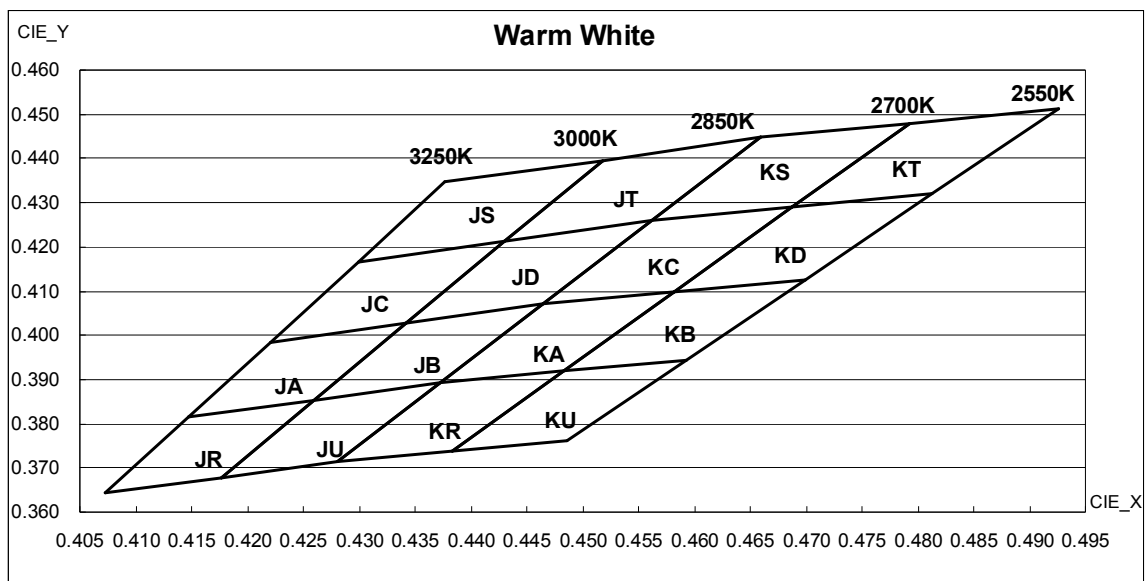

Note: Measurement uncertainty of the chromatic coordinates:  $\pm 0.01$

# Typical Electrical / Optical Characteristic Curves

( 25°C Ambient Temperature Unless Otherwise Noted )

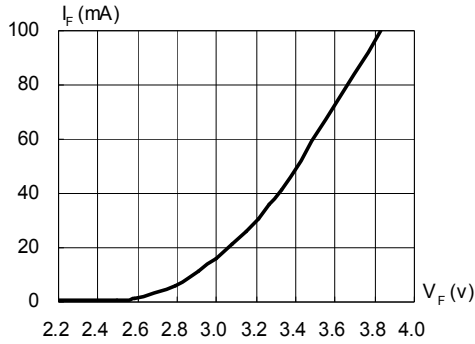

Fig.1 Forward Current vs. Forward Voltage

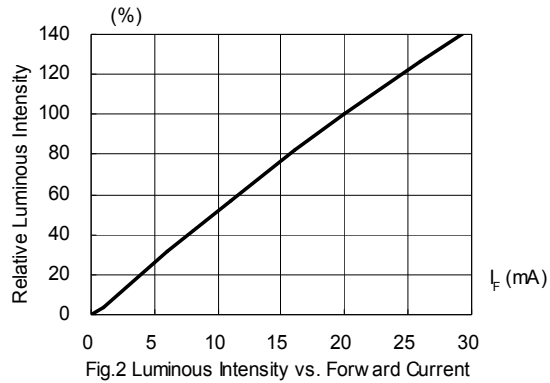

Fig.2 Luminous Intensity vs. Forward Current

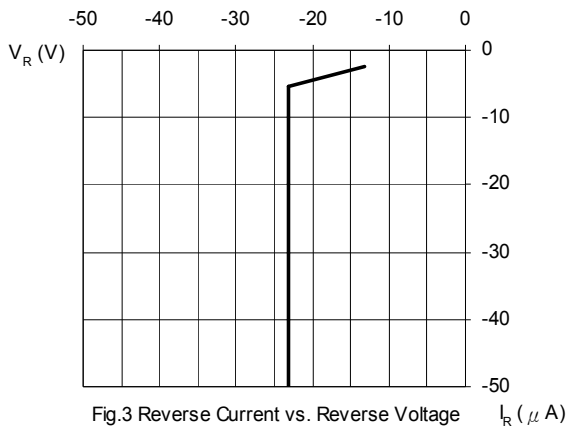

Fig.3 Reverse Current vs. Reverse Voltage

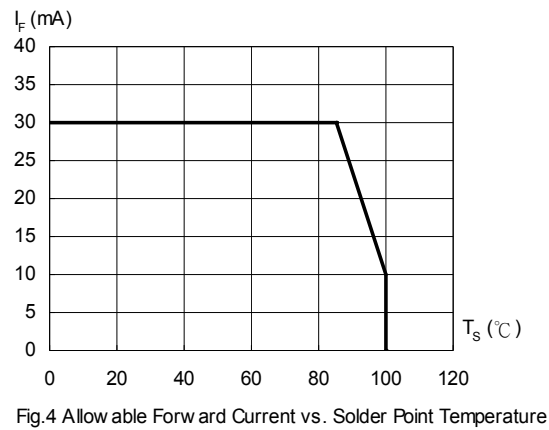

Fig.4 Allowable Forward Current vs. Solder Point Temperature

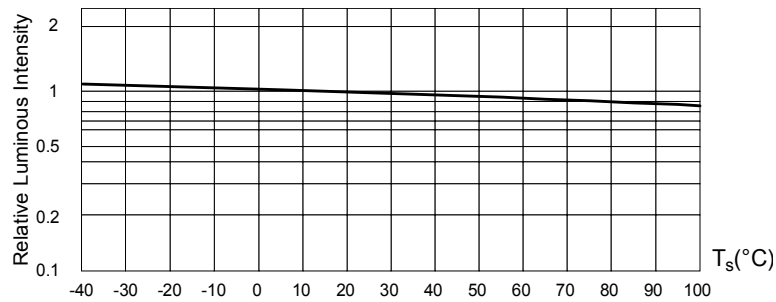

Fig. 5 Luminous Intensity at I<sub>F</sub>=20mA vs. Solder Point Temperature

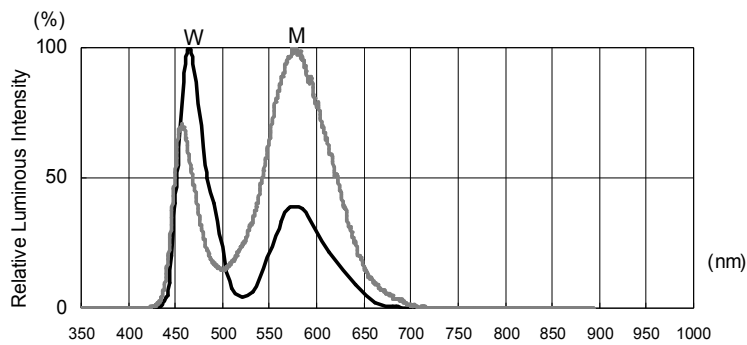

Fig. 6 Relative Luminous Intensity vs. Wavelength

Note: The data shown above are typical values, which do not correspond to the actual parameters of every single LED. These figures can only reflect statistical curves, and the typical data will be changed without further notice.

## Reliability Test

EOI's LED is tested and validated by reliability test based on the following reference standards.

### 1. Test Conditions, Acceptable Criteria and Results:

| Classification   | Test Item                          | Reference Standard         | Test Condition  | Duration   | Units (PCS) | Acc / Rej Criteria | Result |
|------------------|------------------------------------|----------------------------|---|------------|-------------|--------------------|--------|
| Life Test        | Operation Life Test (OLT)          | MIL-STD-750D Method 1027.3 | $T_A=25^{\circ}\text{C}$ , $I_F=30\text{mA}$ *                | 1000 Hrs   | 22          | 0 / 1              | Pass   |
| Environment Test | High Temperature Storage (HTS)     | JESD22-A103                | $T_A=100^{\circ}\text{C}$                                     | 1000 Hrs   | 22          | 0 / 1              | Pass   |
|                  | Low Temperature Storage (LTS)      | JESD22-A119                | $T_A=-40^{\circ}\text{C}$                                     | 1000 Hrs   | 22          | 0 / 1              | Pass   |
|                  | Temp. and Humidity with Bias (THB) | JESD22-A101                | $T_A=85^{\circ}\text{C}$ , $R_h=85\%$<br>$I_F=20\text{mA}$ ** | 500 Hrs    | 22          | 0 / 1              | Pass   |
|                  | Temperature Cycling Test (TCT)     | JESD22-A104                | $-40^{\circ}\text{C} \sim 100^{\circ}\text{C}$<br>15min 15min | 100 cycles | 22          | 0 / 1              | Pass   |
| Mechanical Test  | Solderability                      | JESD22-B102                | $235\pm 5^{\circ}\text{C}$ , 5 sec.                           | 1 time     | 22          | 0 / 1              | Pass   |
|                  | Resistance to Soldering Heat       | J-STD-020                  | Max. $260^{\circ}\text{C}$ , 10 sec.                          | 1 time     | 22          | 0 / 1              | Pass   |

Remark : (\*)  $I_F=30\text{mA}$  for AllInGaP chip ;  $I_F=20\text{mA}$  for InGaN chip

(\*\*)  $I_F=20\text{mA}$  for AllInGaP chip ;  $I_F=10\text{mA}$  for InGaN chip

### 2. Failure Criteria ( $T_A=25^{\circ}\text{C}$ ):

| Test Item             | Test Condition    | Criteria for Judgment |                    |
|-----------------------|-------------------|-----------------------|--------------------|
|                       |                   | Min.                  | Max.               |
| Relative Light Output | $I_F=20\text{mA}$ | $LSL \times 0.7$ **   |                    |
| Forward Voltage       | $I_F=20\text{mA}$ |                       | $USL \times 1.1$ * |

(\*) USL : Upper Standard Level , (\*\*) LSL : Lower Standard Level



## Description of Bin Code

EOI's LEDs are tested and sorted into different bins with individual bin code. The LED bin code is shown on the label of every shipment package, and includes the information of color, brightness, and also forward voltage of LED. Please refer to the rank combination of every product to get detail information of each bin code.

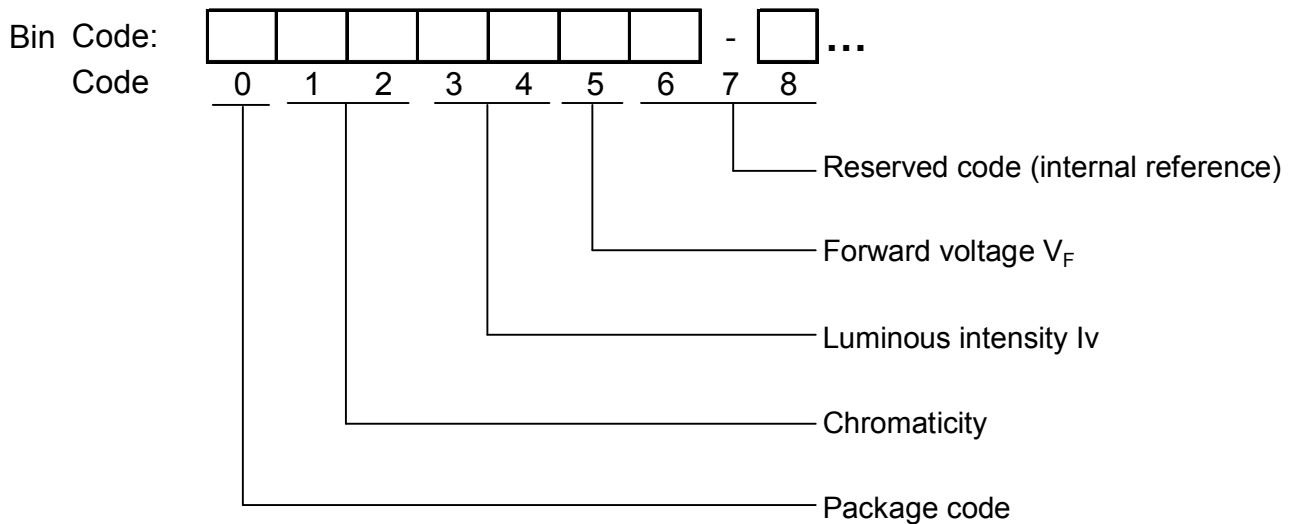

## Precaution of Application

### 1. Circuit layout and design

- (1) Due to the forward voltage of LED will vary with temperature and its driving current, the current-limited protective circuit should be considered in the LED circuit design.

When LEDs are arrayed as parallel circuit, different inherent resistance of LED will cause unbalance current. The unbalanced driving current which exists in every parallel circuit may make LED to be driven at different power. Therefore, the LED driven at higher power may be damaged by over driving current, and the LED driven at lower power may be dimmer than the others.

To solve this situation, a suitable resistor is recommended to put in series with each LED circuit. The resistor will limit and balance the driving current which flows through every parallel circuit.

- (2) For circuit design, current through each LED must not exceed its Absolute Maximum Rating.
- (3) LEDs should be operated in forward bias. A driving circuit must be designed well, so that neither forward nor reverse voltage would be applied to LEDs while power off. Without such correct circuit design, damage may occur on LEDs, especially if a reverse voltage is continuously applied to LEDs.

## 2. Electric Static Discharge (ESD) Protection

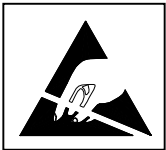

All LED materials, such as GaP, AlGaAs, AlInGaP, GaN, or InGaN chips, are STATIC SENSITIVE device. ESD protection or surge voltages shall be considered and taken care in whole product design and production processes.

The following protection is recommended:

- (1) A wrist band or an anti-electrostatic glove shall be used when handling the LEDs.
- (2) All devices, equipment and machinery must be properly grounded. The whole environments of processing and manufacturing should be controlled and kept in suitable ESD protection level.
- (3) It is recommended to perform electrical tests to screen out ESD failures at final inspection.
- (4) It is important to eliminate the possibility of surge current during circuitry design.

If LED is damaged by ESD or surge voltage, damaged LED may show some unusual characteristics, such as leakage current, dimmer, or no light emission. When damaged LED is inspected at low driving current, black dots may appear within the emitting area.

## 3. Storage

SMD / PLCC devices are MOISTURE SENSITIVE. Please protect LED from moisture all the time, including transportation and storage.

It's recommended to store the products in the following conditions:

- (1) Shelf life in original sealed bag: 12 months at  $T_A < 40^\circ\text{C}$  and Hum.  $< 60\% \text{RH}$ . (Base on aluminum laminated moisture barrier bag.) Baking may be required when the shelf life is expired.
- (2) Before opening the bag, please check the bag is well sealed intact.
- (3) After opening the original sealed bag, please check humidity indicator card first. If color on the

circles of 5% and 10% turns pink, it indicates that the reel of LED needs to be baked. If the color of 15% circle turns pink, please contact with our sales to get further instructions.

(4) After the sealed bag is opened, the LED must be kept in the following environment:

Humidity (Hum.): < 60%RH

Temperature (T<sub>A</sub>): 5°C ~ 30°C

Assembly duration (subject to reflow): within 72 hours

It's recommended to complete LED assembly (subject to reflow) as soon as possible after bag is opened. Re-baking process is required, when exceeding the above assembly duration.

(5) If some of LED are not used after bag is opened, please keep unused LED with moisture absorbent material in moisture proof sealed bags, or airtight container. When these unused LEDs will be used again, pre-qualification should be done before production.

(6) Please avoid rapid transitions in ambient temperature, especially in high humidity environment where condensation can occur.

(7) The surface condition of leads and pads of LED is sensitive to corrosive materials. When LED is exposed to a corrosive environment, it may cause the plated metal parts of LED to be tarnished, which would adversely affect its soldering and optical characteristics.

#### **4. Pick and Place**

Special attention should be paid during assembly process:

(1) It should be avoided to load stress on the resin during pick and place process, especially at high temperature.

(2) It's recommended to choose a suitable nozzle to pick up the SMD products during the process of SMT production. The inner diameter or size of nozzle should be taken care to make sure that the lens of LED will not be touched or pressed by nozzle.

(3) Avoid rubbing or scraping the resin by any object, and avoid leaving fingerprints on the lens.

(4) Electric-static may cause damage to the component. Please ensure all equipment is grounded well.

(5) Some parts of PLCC series are using silicone material as encapsulation material. Silicone material is easily contaminated by particles. However, a small amount of particles on the LEDs will not affect the brightness of the LEDs, and also the lifetime. Therefore, a small amount of particles on the surface of lens of LEDs will not affect the performance.

### 5. Baking

If re-baking process is required, please take LEDs out of package bag, preheat the oven, and then place LEDs into then oven. Don't open the door of oven frequently during baking process. The conditions are suggested as the following:

| Baking Condition | Tapped Reel   | Bulk   |
|------------------|---|--|
|                  | $T_A: 60\pm 3^{\circ}\text{C}$<br>Hum.: $\leq 10\% \text{ RH}$<br>Time: 48~72 hours | $T_A: 110\pm 3^{\circ}\text{C}$<br>Hum.: $\leq 10\% \text{ RH}$<br>Time: 12~24 hours |

### 6. Manual Soldering (Using Soldering Iron)

The manual soldering process is not recommended for quality consideration. When it is absolutely necessary, the LEDs may be mounted in this fashion but the customer will assume responsibility for any problems.

The following conditions are recommended:

- (1) Soldering material: solder with silver content is recommended.
- (2) Temperature of the iron:  $\leq 300^{\circ}\text{C}$
- (3) Soldering time: max. 3 seconds
- (4) Operating cautions:
  - Please avoid overheating of LED component in any process. Overheating could damage the LED package.
  - Please don't place any stress on the lens of LED, especially at high temperature.
  - In order to ensure LED could make good heat dissipation and work normally, the user should take care of the connection between thermal pads of LED and pads of PCB during soldering process.

## 7. Reflow Soldering

To prevent LED from cracking in reflow process, it's better to bake LED components before reflow soldering. After the package sealing bag is opened, please use the LED device as soon as possible to keep LED from moisture.

It's banned to load any stress on the resin during soldering. Never take next process until the component is cooled down to room temperature after reflow. And, the manual soldering process is not recommended for quality consideration.

To ensure the performance of LED device, it is recommended to set up a reflow profile at lower temperature, and reflow soldering should not be done more than one time.

The recommended reflow soldering profile (measure point is near the bottom of the LED package) is following:

**Recommended Pb-free Soldering Profile**

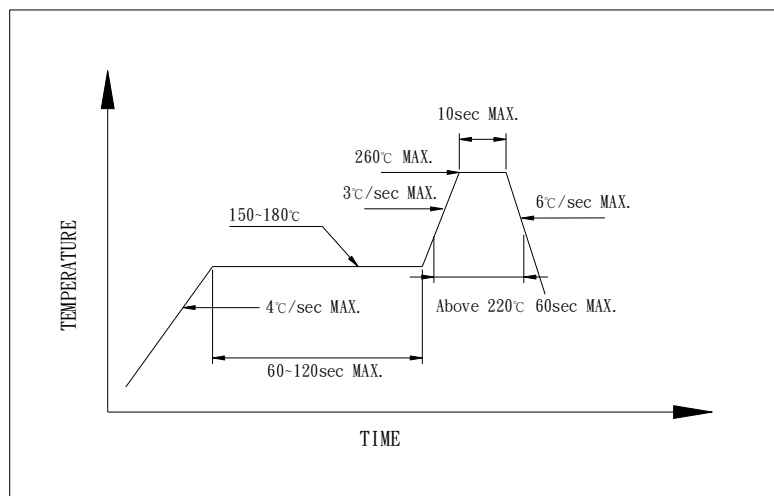

The soldering paste should be coated to the necessary area of soldering pads by the screen-printing or with the dispenser. In the case of the screen-printing, it is recommended to have the thickness of 0.1mm to 0.2mm. The optimal thickness should be verified by pre-test, and will be different from every different layout of leads of LED.

Repairing should not be done after the LEDs have been soldered. When repairing is necessary, the double-head soldering iron/ heat gun/ heat plate could be used if the LED needs to be removed. The removed LEDs shall not be used again. Please refer to the recommendations for manual soldering if additional rework is needed.

## 8. Cleaning

An alcohol-based solvent such as isopropyl alcohol (IPA) is recommended to clean the LED bulbs, if cleaning is necessary. Before cleaning, a pre-test should be done to confirm whether any damage to the LEDs will occur if cleaning solvent is used.

It is not recommended to use unspecified chemical liquids, and also ultrasonic power during cleaning process. The chemical and ultrasonic power could harm the LED devices.

## 9. Others

- (1) The strong light from LEDs may injure human eyes. Precautions should be taken to prevent looking directly at the LEDs with unaided eyes.
- (2) LED device is very sensitive to heat. In order to get maximum light output during the duration of LED's long life, designer should consider the best methods and design for thermal dissipation when designing the entire system. It's recommended to avoid intense heat generation and to operate within the maximum ratings given in this specification.
- (3) Every piece of LED will be sorted and LEDs with the same binning grade will be taped into the same reel or put into the same bag. It is recommended to use the same bin-grade LED to assemble the unit module. This will ensure the LED unit module with good uniformity of brightness, hue, and so on.
- (4) For outdoor usage, necessary measure should be taken to prevent the damage from water, moisture and salt spray.
- (5) Do not use sulfur-containing materials in commercial products.

## Terms and Condition

1. EOI warrants all sold LEDs which conform to the specifications approved by the customers.
2. Any LED supplied by EOI is found not conform to the specifications that both parties agreed upon, customer should claim within 30 days of receipt.
3. EOI will not hold any responsibility for the failed LEDs, which are caused by mishandling or misusing the LEDs exceeding the operating conditions that EOI suggested.
4. EOI's LED products are designed and manufactured for general electronic equipment (such as household appliances, communication equipment, office equipment, electronic instrumentation and so on). If customer's application requires exceptional quality or reliability, which might concern human safety, it is necessary to consult with EOI in advance.
5. All the information published is considered to be reliable. However, EOI does not assume any liability arising out of the application or use of any product described herein. EOI's liability for defective LED lamps shall only be limited to replacement, in no event shall EOI be liable for consequential damages or loss.
6. EOI and customer shall both confirm the specifications herein, and all quality related matters will base on the specifications both parties agreed upon.
7. The information in this documentation is subject to change without notice.

© All rights reserved. Product specifications are subject to change without notice.



### Headquarters Excellence Opto. Inc.

No.2, Kedong 1st Road, Chunan Town, Miaoli County,  
Hsinchu Science Park, Taiwan 35053, R.O.C.  
Tel: 886-37-539000 Fax: 886-37-586789  
E-mail: Service@eoi.com.tw  
<http://www.eoi.com.tw>

### China Subsidiary Lianxinfeng Opto. Co., Ltd. (LXF)

1F, Bldg., No. 15, Tongfuyu Industrial Park, Hwa-Wang  
Road, Ton-Sheng Community, Da-Lang, Bao-An  
District, ShenZhen City, Guangdong Province, China  
Tel: 86-755-2814-0029 Fax: 86-755-2814-0027

### U.S. Company Excellence Opto. Inc.

1663 West 2nd Street, Pomona, CA 91766, U.S.A.  
Tel: 909-784-3333 Fax: 909-784-3330  
E-mail: Sales@eoius.com