

PART NO. : **EOQ-5PMFPC0-EG**



**Through Hole LED**

**5mm Round 30° Warm White Color**

**Data Sheet**

### **Features**

- Standard T-1 3/4 package
- High brightness InGaN LED
- High efficiency
- ESD class 1
- Emission color  $x=0.41, y=0.39$
- Pb free & RoHS compliant product

### **Applications**

- Indicator
- Back lighting

## Outline Drawings

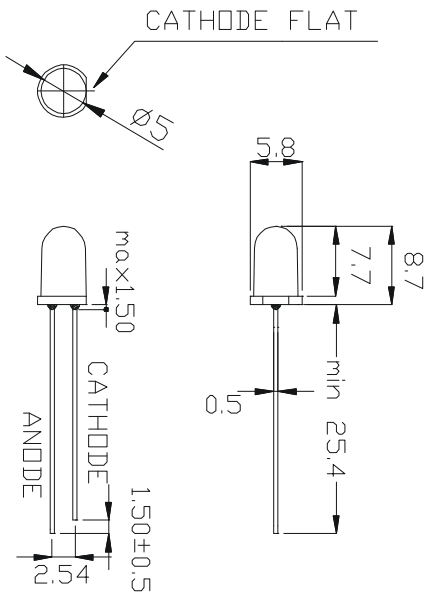

## Beam Pattern

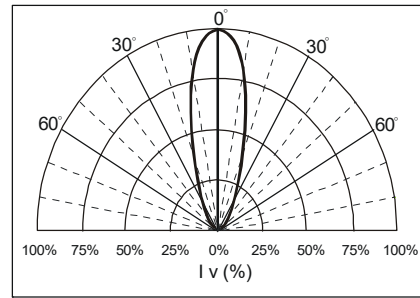

### Note:

1. All dimensions are in millimeter.
2. Tolerance is  $\pm 0.20$ mm unless otherwise noted.
3. Protruded resin under bottom surface of epoxy is 1.5mm max.
4. Lead spacing is measured where the leads emerge from the package.

Lens Color	Beam Color	Leadframe Material	Stand Off	Flange
Clear	Warm White	Iron base	No	Yes

## Absolute Maximum Ratings at $T_A=25^\circ\text{C}$

Parameter	Symbol	Max.	Unit
Average Forward Current <sup>[1]</sup>	$I_F$	25	mA
Peak Forward Current <sup>[2]</sup>	$I_{peak}$	100	mA
Reverse Voltage <sup>[3]</sup>	$V_R$	5	V
Power Dissipation	$P_D$	100	mW
Current Linearity vs. Ambient Temperature	$TC_I$	-0.29	mA/°C
LED Junction Temperature	$T_J$	125	°C
Operating Temperature Range <sup>[1]</sup>	$T_{OPR}$	-40 ~ 100	°C
Storage Temperature Range	$T_{STO}$	-40 ~ 100	°C
Lead Soldering Condition	$T_{SOL}$	Below 260°C, Max. 3 seconds	

Note: 1. Design of heat dissipation should be considered. For the allowable operating current at different operating temperature, please refer to fig 4. page 5.

2. Duty ratio=1/10, pulse width=0.1ms.

3. This device is not designed for reverse voltage application. The reverse voltage or current may damage LED.

## Electrical and Optical Characteristics at $T_A=25^\circ\text{C}$

Parameter	Symbol	Min.	Typ.	Max.	Unit	Test Condition
Luminous Intensity	$I_v$	8550	12500	---	mcd	$I_F=20\text{mA}$
Viewing Angle	$2\theta_{1/2}$	---	30	---	Deg	$I_F=20\text{mA}$
Chromaticity Coordinate	x	---	0.41	---	---	$I_F=20\text{mA}$
	y	---	0.39	---	---	
Spectral Half Width	$\Delta\lambda$	---	25	---	nm	$I_F=20\text{mA}$
Forward Voltage	$V_F$	2.6	3.2	4.0	V	$I_F=20\text{mA}$
Reverse Current	$I_R$	---	---	10	$\mu\text{A}$	$V_R=5\text{V}$

## Rank Combination

Luminous Intensity $I_v(\text{mcd}) @I_F=20\text{mA}$			Forward Voltage $V_F(\text{V}) @I_F=20\text{mA}$		
Min.	Max.	Code	Min.	Max.	Code
8550	11970	<b>0Y</b>	2.6	2.8	<b>A</b>
11970	16758	<b>0Z</b>	2.8	3.0	<b>B</b>
16758	23500	<b>Z1</b>	3.0	3.2	<b>C</b>
-	-	-	3.2	3.4	<b>D</b>
-	-	-	3.4	3.6	<b>E</b>
-	-	-	3.6	3.8	<b>F</b>
-	-	-	3.8	4.0	<b>G</b>

Note: 1. All of rank combinations which include luminous intensity, dominant wavelength, and forward voltage will be included in every shipment.

2. Measurement uncertainty of the luminous intensity:  $\pm 15\%$

3. Measurement uncertainty of the voltage:  $\pm 0.1\text{V}$

## Chromaticity Coordinate Specifications for Bin Grading

CCT (K)	Bin Code	CIE Bin Coordinates	CCT (K)	Bin Code	CIE Bin Coordinates
4400-4600K	L1	(0.3588,0.3703)(0.3610,0.3850)(0.3704,0.3916)(0.3674,0.3761)	4000-4200K	N1	(0.3760,0.3820)(0.3799,0.3983)(0.3893,0.4049)(0.3846,0.3878)
	L2	(0.3567,0.3555)(0.3588,0.3703)(0.3674,0.3761)(0.3644,0.3606)		N2	(0.3722,0.3657)(0.3760,0.3820)(0.3846,0.3878)(0.3799,0.3708)
	L3	(0.3545,0.3408)(0.3567,0.3555)(0.3644,0.3606)(0.3614,0.3451)		N3	(0.3683,0.3494)(0.3722,0.3657)(0.3799,0.3708)(0.3752,0.3537)
4200-4400K	M1	(0.3674,0.3761)(0.3704,0.3916)(0.3799,0.3983)(0.3760,0.3820)	3800-4000K	P1	(0.3846,0.3878)(0.3893,0.4049)(0.3899,0.4116)(0.3933,0.3937)
	M2	(0.3644,0.3606)(0.3674,0.3761)(0.3760,0.3820)(0.3722,0.3657)		P2	(0.3799,0.3708)(0.3846,0.3878)(0.3933,0.3937)(0.3877,0.3759)
	M3	(0.3614,0.3451)(0.3644,0.3606)(0.3722,0.3657)(0.3683,0.3494)		P3	(0.3752,0.3537)(0.3799,0.3708)(0.3877,0.3759)(0.3822,0.3580)
3600-3800K	Q1	(0.3933,0.3937)(0.3988,0.4116)(0.4088,0.4164)(0.4025,0.3981)	3300-3400K	S1	(0.4118,0.4026)(0.4189,0.4213)(0.4289,0.4261)(0.4210,0.4070)
	Q2	(0.3877,0.3759)(0.3933,0.3937)(0.4025,0.3981)(0.3961,0.3799)		S2	(0.4046,0.3839)(0.4118,0.4026)(0.4210,0.4070)(0.4131,0.3879)
	Q3	(0.3822,0.3580)(0.3877,0.3759)(0.3961,0.3799)(0.3898,0.3615)		S3	(0.3975,0.3650)(0.4046,0.3839)(0.4131,0.3879)(0.4052,0.3687)
3400-3600K	R1	(0.4025,0.3981)(0.4088,0.4164)(0.4189,0.4213)(0.4118,0.4026)	3200-3300K	T1	(0.4210,0.4070)(0.4289,0.4261)(0.4390,0.4310)(0.4303,0.4115)
	R2	(0.3961,0.3799)(0.4025,0.3981)(0.4118,0.4026)(0.4046,0.3839)		T2	(0.4131,0.3879)(0.4210,0.4070)(0.4303,0.4115)(0.4216,0.3920)
	R3	(0.3898,0.3615)(0.3961,0.3799)(0.4046,0.3839)(0.3975,0.3650)		T3	(0.4052,0.3687)(0.4131,0.3879)(0.4216,0.3920)(0.4129,0.3725)
2950-3200K	U1	(0.4303,0.4115)(0.4390,0.4310)(0.4535,0.4349)(0.4438,0.4150)	2700-2800K	W1	(0.4573,0.4186)(0.4680,0.4388)(0.4825,0.4427)(0.4708,0.4221)
	U2	(0.4216,0.3920)(0.4303,0.4115)(0.4438,0.4150)(0.4340,0.3951)		W2	(0.4465,0.3983)(0.4573,0.4186)(0.4708,0.4221)(0.4590,0.4015)
	U3	(0.4129,0.3725)(0.4216,0.3920)(0.4340,0.3951)(0.4243,0.3753)		W3	(0.4358,0.3781)(0.4465,0.3983)(0.4590,0.4015)(0.4473,0.3809)
2800-2950K	V1	(0.4438,0.4150)(0.4535,0.4349)(0.4680,0.4388)(0.4573,0.4186)	2600-2700K	X1	(0.4708,0.4221)(0.4825,0.4427)(0.4970,0.4466)(0.4843,0.4257)
	V2	(0.4340,0.3951)(0.4438,0.4150)(0.4573,0.4186)(0.4465,0.3983)		X2	(0.4590,0.4015)(0.4708,0.4221)(0.4843,0.4257)(0.4715,0.4047)
	V3	(0.4243,0.3753)(0.4340,0.3951)(0.4465,0.3983)(0.4358,0.3781)		X3	(0.4473,0.3809)(0.4590,0.4015)(0.4715,0.4047)(0.4588,0.3838)

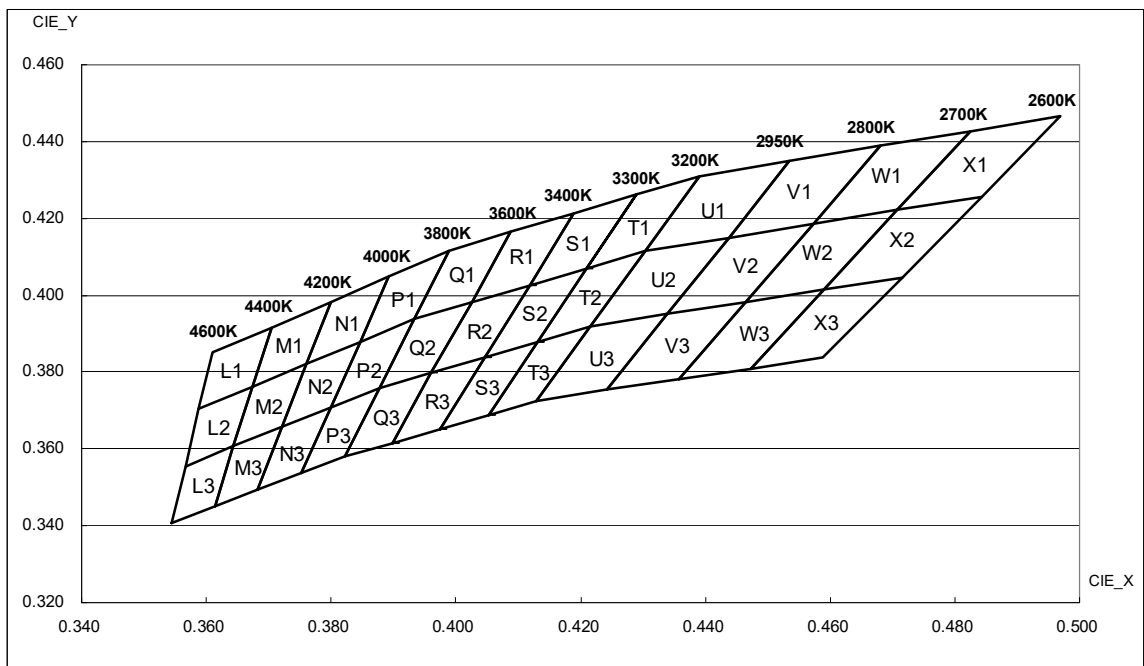

Note: 1. Measurement Uncertainty of the Chromatic Coordinates:  $\pm 0.01$

## Typical Electrical / Optical Characteristic Curves

( 25°C Ambient Temperature Unless Otherwise Noted )

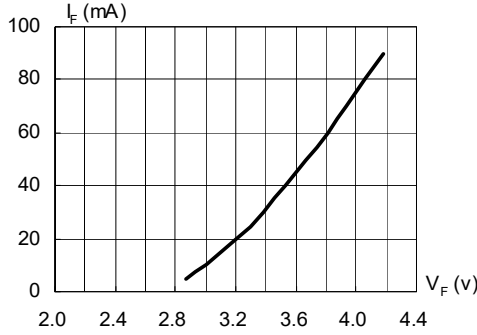

Fig.1 Forward Current vs. Forward Voltage

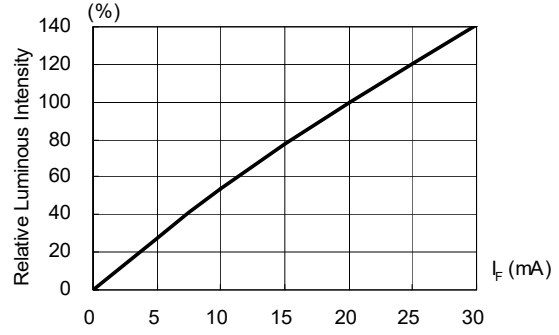

Fig.2 Luminous Intensity vs. Forward Current

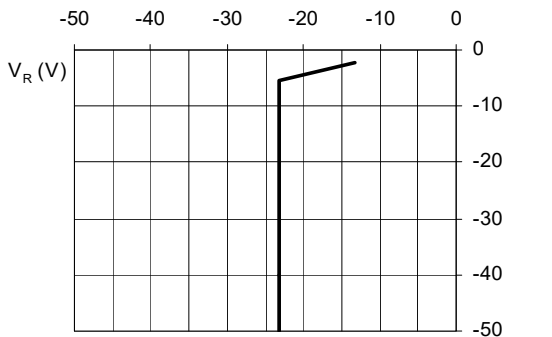

Fig.3 Reverse Current vs. Reverse Voltage

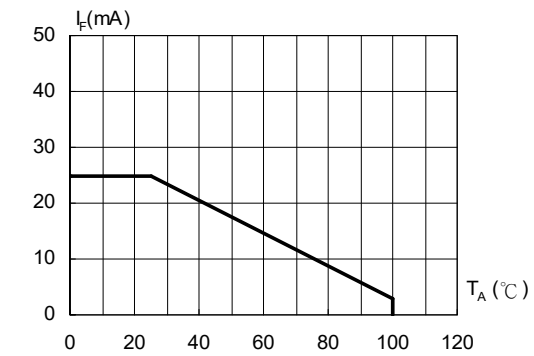

Fig.4 Allowable Forward Current vs. Ambient Temperature

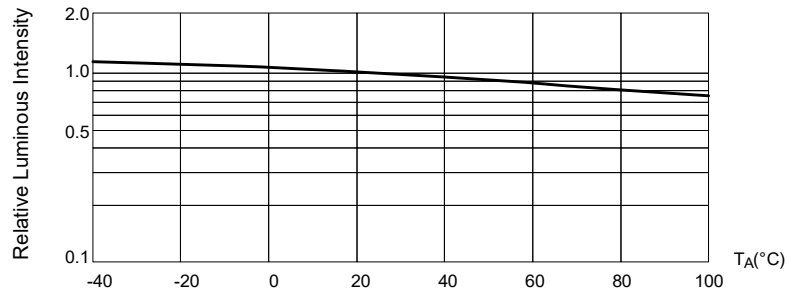

Fig. 5 Luminous Intensity at  $I_F = 20mA$  vs. Ambient Temperature

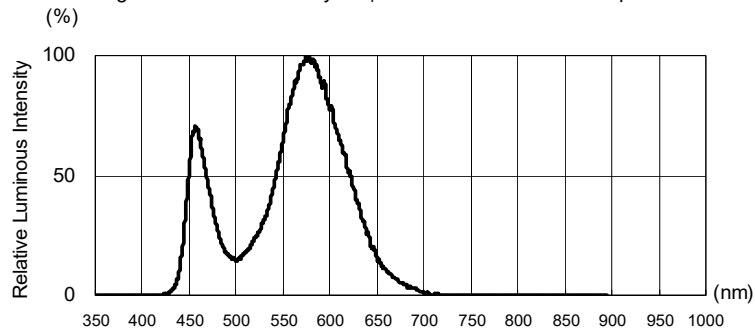
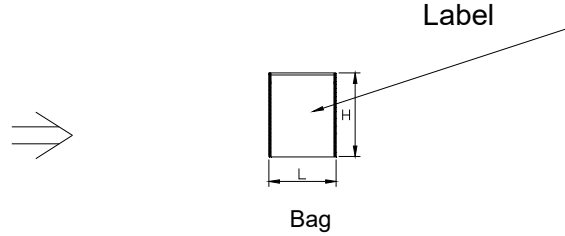

Fig 6. Relative Luminous Intensity vs. Wavelength

Note: The data shown above are typical values, which do not correspond to the actual parameters of every single LED. These figures can only reflect statistical curves, and the typical data will be changed without further notice.

# Bulk Package

Anti-static/anti-corrosion bag
H : 200mm
L : 180mm
PCS/BAG
3.0/4.0/5.0mm: Max. 500pcs
>7.5mm : Max. 400pcs
>10mm : Max. 250pcs



P/N: EOX-XXXXXXXX-XX		EOI EXCELLENCE OPTO. INC.	
LOT:XXXXXXXXXX		EOX-XXXXXX-XX	
Bin Code:XXXXXX		PROGRAM:	
QTY(pcs):XXXX		CARTON ID:	
QA Date:		RoHS Pb	
DEPT ID:T/H			
Made in China			

Corrugated paper box(3 layers)
H : 140mm
L : 350mm
W : 260mm
PCS/Inner Box
3.0/4.0/5.0mm: Max. 10K pcs
>7.5mm : Max. 4K pcs
>10mm : Max. 2.5K pcs

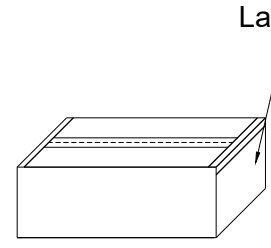
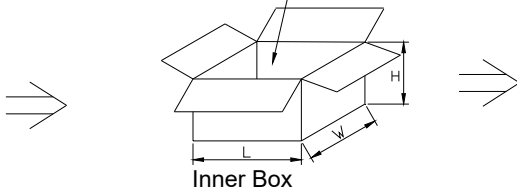

Corrugated paper box(5 layers)
H : 320mm
L : 380mm
W : 280mm
PCS/Outer Box
3.0/4.0/5.0mm: Max. 20K pcs
>7.5mm : Max. 8K pcs
>10mm : Max. 5K pcs

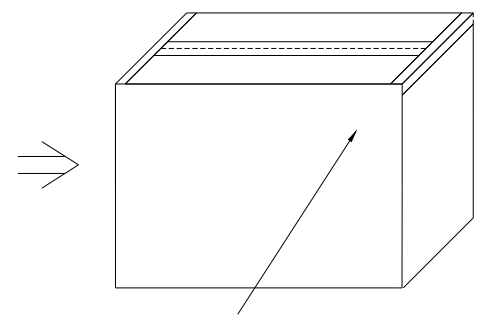
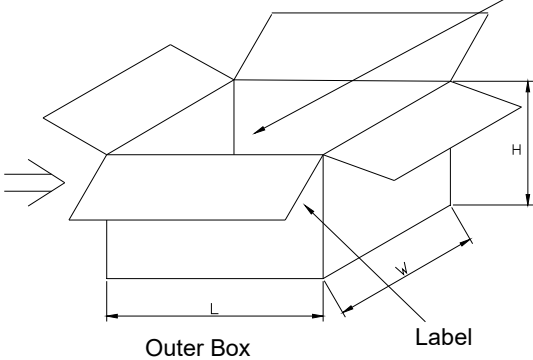

EOI EXCELLENCE OPTO. INC.			RoHS Pb
Customer			
P.O.No.			
Part NO.	EOX-XXXXXX-XX		
	Bin Code	Qty(PCS)	
Total			

Label

# Taping Package (TT-0001)

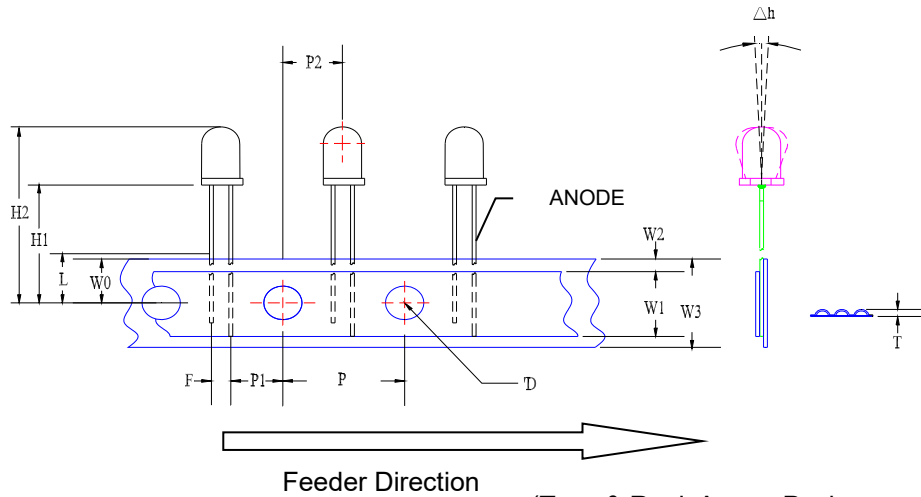

(Tape & Reel, Ammo Pack are available)

(Maximum 10 inner boxes in one outer box)

Item	Symbol	Specification			
		Minimum		Maximum	
		mm	inch	Mm	inch
· Tape Feed Hole Diameter	D	3.8	0.149	4.2	0.165
· Component Lead Pitch	F	2.34	0.092	2.74	0.108
· Front To Rear Deflection	$\Delta h$	--	--	2.0	0.078
· Feed Hole To Bottom Of Component	H1	19.0	0.709	21.0	0.787
· Feed Hole To Overall Component Height	H2	--	--	32.00	1.260
· Lead Length After Component Height	L	W0		11.0	0.433
· Feed Hole Pitch	P	12.4	0.488	13.0	0.511
· Lead Location	P1	4.4	0.173	5.8	0.228
· Center Of Component Location	P2	5.05	0.198	7.65	0.301
· Total Tape Thickness	T	--	--	1.4	0.056
· Feed Hole Location	W0	8.5	0.334	9.50	0.374
· Adhesive Tape Width	W1	12.0	0.472	14.0	0.551
· Adhesive Tape Position	W2	--	--	4.0	0.157
· Tape Width	W3	17.5	0.689	19.0	0.748



Label

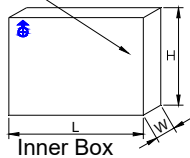

Inner Box

Corrugated paper box(3 layers)	
H :	250mm
L :	330mm
W :	50mm
PCS/Inner Box	
3/4mm :	Max. 2.5K pcs
5.0mm :	Max. 2K pcs
> 7.5mm :	Max. 1K pcs

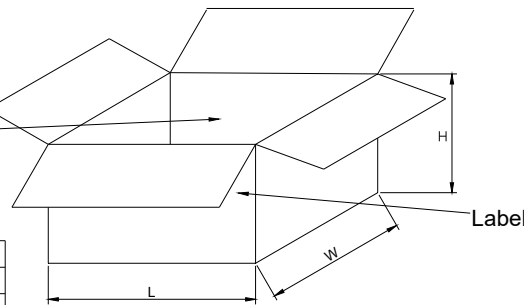

Outer Box

Corrugated paper box(5 layers)	
H :	290mm
L :	520mm
W :	360mm
PCS/Outer Box	
3/4mm :	Max. 25K pcs
5.0mm :	Max. 20K pcs
> 7.5mm :	Max. 10K pcs

EXCELLENCE OPTO. INC.	
Customer	
P.O.No.	
Part No.	EOX-XXXXXX-XX
Tapping Part No.	EOX-XXXXXX-XX-TT-XXXX
	Bin Code Q'ty(PCS)

Note: Several standard types of taping package are available.  
Please contact with our salesman to get detail information.



- (2) For circuit design, current through each LED must not exceed its Absolute Maximum Rating.
- (3) LEDs should be operated in forward bias. A driving circuit must be designed well, so that neither forward nor reverse voltage would be applied to LEDs while power off. Without such correct circuit design, damage may occur on LEDs, especially if a reverse voltage is continuously applied to LEDs.

## 2. Electric Static Discharge (ESD) Protection

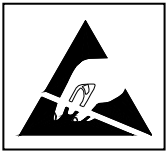

All LED materials, such as GaP, AlGaAs, AlInGaP, GaN, or InGaN chips, are STATIC SENSITIVE device. ESD protection or surge voltages shall be considered and taken care in whole product design and production processes.

The following protection is recommended:

- (1) A wrist band or an anti-electrostatic glove shall be used when handling the LEDs.
- (2) All devices, equipment and machinery must be properly grounded. The whole environments of processing and manufacturing should be controlled and kept in suitable ESD protection level.
- (3) It is recommended to perform electrical tests to screen out ESD failures at final inspection.
- (4) It is important to eliminate the possibility of surge current during circuitry design.

If LED is damaged by ESD or surge voltage, damaged LED may show some unusual characteristics, such as leakage current, dimmer, or no light emission. When damaged LED is inspected at low driving current, black dots may appear within the emitting area.

## 3. Lead Forming

The leads should not be bent or cut at the point of 3mm or shorter than 3mm from the base of the epoxy bulb while forming the leads. It's recommended to cut or form the lead by tooling made rather than by hand operation.

Do not apply any bending stress to the base of the lead, and don't cause any stress after mounting the LED lamp on PCB. The stress to the base may damage LED's characteristics, or cause deterioration of the epoxy resin. This will hurt and degrade the LEDs.

When auto-insertion machine is used in assembly process, pre-qualification is required to check the quality of inserted LEDs. For 3mm through-hole LED, it's recommended to use manual insertion.

#### 4. Storage

It is recommended to store the LEDs in the following conditions:

- (1) Shelf life in original package: 12 months at  $T_A < 40^\circ\text{C}$  and humidity  $< 60\%RH$ .
- (2) After the package is opened, the LED must be kept in the following environment:

Humidity (Hum.):  $< 60\%RH$

Temperature ( $T_A$ ):  $5^\circ\text{C} \sim 30^\circ\text{C}$

Assembly duration (subject to wave soldering): within 168 hours

The LED should be used completely as soon as possible. If some of LED are not used, it's recommended to keep LED with moisture absorbent material in moisture proof sealed bags, or airtight container. When these unused LEDs will be used again, pre-qualification of soldering process should be done before production.

Although the leads of LED lamp are plated with pure tin to protect leads from corrosion, devices should be subjected to wave soldering, or equivalent process as soon as possible (within the above assembly duration), after the original package is opened. Exposure to a corrosive environment may cause the plated metal parts of product to be tarnished, which would adversely affect the solderability of LEDs.

If some of LEDs are not used, it's recommended to keep LED with moisture absorbent material in moisture proof sealed bags, or airtight container, in order to protect LEDs from corrosion and moisture. When these unused LEDs will be used again, pre-qualification of soldering process should be done before production.

Please avoid rapid transitions in ambient temperature, especially in high humidity environment where condensation can occur.

## 5. Soldering

Soldering heat may damage the LED. Careful attention should be paid during soldering and PCB assembly processes. In order to eliminate the stress of heat shock, please solder the LEDs no close than 3mm form the base of the epoxy bulb.

Recommended soldering condition:

	Wave Soldering	Manual Solder Dipping	Hand soldering by iron
Pre-heat Temperature	105°C Max.	-	
Pre-heat Time	30 sec. Max.	-	
Peak Temperature	260°C Max.	260°C Max.	350°C Max.
Dwell Time	3 sec. Max.	5 sec. Max.	3 sec. Max.

Recommended Wave Solder Temperature Profile

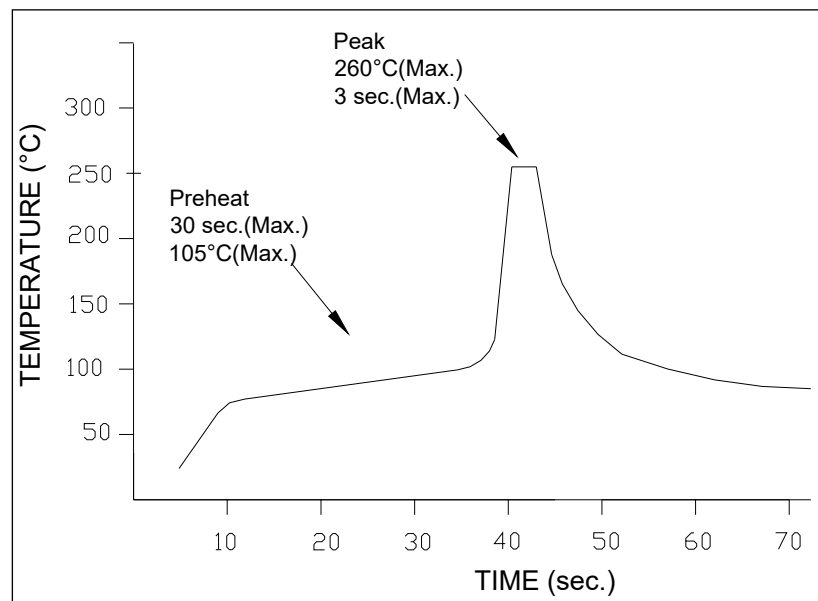

Care should be taken to avoid cooling at a rapid rate, and ensure the peak temperature ramps down slowly.

Never take next process until the component is cooled down to room temperature after soldering. It's banned to load any stress on the resin during soldering. If it's necessary to clamp the LED bulbs to help soldering, it is important to ensure no mechanical stress on the LEDs.

Any kinds of soldering process must not be performed more than one time. Direct soldering to double-side PCBs must be avoided, to keep the LED from overheat damage.

Repairing should not be done after the LEDs have been soldered. When repairing is necessary, the soldering iron or heat gun could be used if the LED needs to be removed. The removed LEDs shall not be used again. Please refer to the recommendations for manual soldering if additional rework is needed.

## 6. Manual Soldering (Using Soldering Iron)

The manual soldering process is not recommended for quality consideration. When it is absolutely necessary, the LEDs may be mounted in this fashion but the customer will assume responsibility for any problems.

The following conditions are recommended:

- (1) Soldering material: solder with silver content is recommended.
- (2) Temperature of the iron :  $\leq 300^{\circ}\text{C}$
- (3) Soldering time: max. 3 seconds
- (4) Operating cautions:
  - Please avoid overheating of LED component in any process. Overheating could damage the LED package.
  - Please don't place any stress on the lens of LED, especially at high temperature.

## 7. Cleaning

An alcohol-based solvent such as isopropyl alcohol (IPA) is recommended to clean the LED bulbs, if cleaning is necessary. Before cleaning, a pre-test should be done to confirm whether any damage to the LEDs will occur if cleaning solvent is used.

It is not recommended to use unspecified chemical liquids, and also ultrasonic power during cleaning process. The chemical and ultrasonic power could harm the LED devices.

## 8. Others

- (1) The strong light from LEDs may injure human eyes. Precautions should be taken to prevent looking directly at the LEDs with unaided eyes.
- (2) LED device is very sensitive to heat. In order to get maximum light output during the duration of LED's long life, designer should consider the best methods and design for thermal dissipation when designing the entire system. It's recommended to avoid intense heat generation and to operate within the maximum ratings given in this specification.
- (3) Every piece of LED will be sorted and LEDs with the same binning grade will be taped into the same reel or put into the same tube or bag. It is recommended to use the same bin-grade LED to assemble the unit module. This will ensure the LED unit module with good uniformity of brightness, hue, and so on.
- (4) For outdoor usage, necessary measure should be taken to prevent the damage from water, moisture and salt spray.
- (5) Do not use sulfur-containing materials in commercial products.

## Terms and Condition

1. EOI warrants all sold LEDs which conform to the specifications approved by the customers.
2. Any LED supplied by EOI is found not conform to the specifications that both parties agreed upon, customer should claim within 30 days of receipt.
3. EOI will not hold any responsibility for the failed LEDs, which are caused by mishandling or misusing the LEDs exceeding the operating conditions that EOI suggested.
4. EOI's LED products are designed and manufactured for general electronic equipment (such as household appliances, communication equipment, office equipment, electronic instrumentation and so on). If customer's application requires exceptional quality or reliability, which might concern human safety, it is necessary to consult with EOI in advance.
5. All the information published is considered to be reliable. However, EOI does not assume any liability arising out of the application or use of any product described herein. EOI's liability for defective LED lamps shall only be limited to replacement, in no event shall EOI be liable for consequential damages or loss.
6. EOI and customer shall both confirm the specifications herein, and all quality related matters will base on the specifications both parties agreed upon.
7. The information in this documentation is subject to change without notice.

© All rights reserved. Product specifications are subject to change without notice.



**Headquarters  
Excellence Opto. Inc.**

No.2, Kedong 1st Road, Chunan Town, Miaoli County, Hsinchu Science Park, Taiwan 35053, R.O.C.  
Tel: 886-37-539000 Fax: 886-37-586789  
E-mail: Service@eoi.com.tw  
http://www.eoi.com.tw

**U.S. Company  
Excellence Opto. Inc.**

1663 West 2nd Street, Pomona, CA 91766, U.S.A.  
Tel: 909-784-3333 Fax: 909-784-3330  
E-mail: Sales@eoius.com  
http://www.eoius.com

**China Subsidiary I  
Excellence Opto. (DongGuan) Ltd.**

No. 33, HaiBin Road, Wusha Community, Chang-An Town, DongGuan City, P.R.O.C.  
Tel: 86-769-89236999 Fax: 86-769-89236688

**China Subsidiary II  
Lianxinfeng Opto. Co., Ltd. (LXF)**

1~3/F, Building 5, AoHua Industrial Park, No. 148, HuaRong Road, GaoFeng Community, DaLang Office, LongHua, ShenZhen City, GuangDong Province, P.R.O.C.  
Tel: 86-755-28140029 Fax: 86-755-28140027  
http://www.eoi-lxf.com